



## KEY FEATURES

- High-Output Coaxial Active Stage Monitor
- Coaxial Transducers, 14" woofer, 2" HF compression driver
- Single magnet neodymium motor
- 80° constant coverage
- Dual angle monitor configuration (45° or 55°)
- 96KHz / 40bit floating point CORE processing with PRONET remote control
- Digitally controlled Class D amplifier module with SMPS
- Dual-angle pole holder for multi-purpose applications
- Very compact & lightweight with low-profile design

## APPLICATIONS

- Live Stage monitoring
- TV and broadcast
- Theatres
- Corporate and A/V
- House of Worship

## TECHNICAL SPECIFICATIONS

### SYSTEM

System's Acoustic Principle	2-way coaxial vented enclosure
Frequency Response ( $\pm 3$ dB)	70 Hz – 18 kHz (Processed)
Horizontal Coverage Angle	80° (-6dB)
Vertical Coverage Angle	80° (-6dB)
Maximum (peak) SPL	131 dB SPL @ 1m

### TRANSDUCERS

LF	One 14" (355mm), 3"(75mm) voice coil, waterproof cone
HF	One 2" driver, 3" (75mm) aluminium voice coil, polyester/titanium diaphragm

### ELECTRICAL

Input Impedance	20 k $\Omega$ balanced, 10 k $\Omega$ unbalanced
Input Sensitivity	+4dBu / 1.25V
Signal Processing	CORE processing, 96kHz / 40bit floating point SHARC DSP, 24 bit AD/DA converters
Direct Access Control	4 Presets (NORMAL WEDGE/COUPLED/LOW CUT/USER), Network Termination, GND Link
Remote Control	PRONET AX control software
Network Protocol	CANBUS
Amplifier Type	Class D with SMPS
Output Power	900W + 300W
Mains Voltage Range (Vac)	230V $\pm 15\%$ - 115 $\pm 15\%$ 50/60Hz (internally selectable)
IN / OUT Connectors	Neutrik <sup>®</sup> XLR-M / XLR-F
IN / OUT Network Connectors	Neutrik <sup>®</sup> etherCON™ (NE8FAV)
Mains Input Connector	Neutrik <sup>®</sup> powerCON™ (NAC3MPA)
Mains Link Connector	Neutrik <sup>®</sup> powerCON™ (NAC3MPB)
Cooling	Variable speed DC fan

### ENCLOSURE & CONSTRUCTION

Dimensions	507mm W x 316mm H x 403mm D
Taper	Stage Monitor: 45° and 55°
Pole holder	One on the side, dual angle
Enclosure Material	15mm, reinforced phenolic birch
Paint	High resistance, black water based paint
Net Weight	16 kg / 35.3 lbs



## DESCRIPTION

The CX14A is a coaxial stage monitor designed specifically for live sound, although the very compact, low-profile enclosure also makes it suitable for theatre and television applications. The combination of a high-performance coaxial transducer, a carefully designed cabinet, and powerful electronics provides very high SPL before feedback and excellent intelligibility even at very high power.

The transducer's coaxial design offers a very stable acoustical pattern in both the horizontal and vertical axes. The very compact, single magnet neodymium motor reduces the delay between the two sources, eliminating time and phase problems, and guarantees high performance with a consistent weight reduction.

The high frequency range is reproduced by a low-distortion compression driver equipped with a 3" aluminium voice coil and polyester/titanium diaphragm. The special shape of the cone allows precise and controlled conical dispersion of 80°.

The 14" woofer employed in the reproduction of the low frequency range is equipped with a 3" voice coil. Thanks to a special treatment process that makes the cone water repellent, the CX14A is able to perform in adverse weather conditions and is therefore suitable for outdoor use.

## CABINET DESIGN

The reduced size of the baltic birch cabinet (only 32cm high and 51cm wide) makes the CX14A one of the most compact and lightweight stage monitors in its category, and makes it suitable for all applications where unobtrusive size is a must. This includes not only live concerts, but also theatre shows and TV applications.

The reduced weight (17 kg) and the ergonomic handles on both sides of the cabinet make it very easy to transport the monitor and to position it on stage. A convenient dual-angle pole holder allows the CX14A to be mounted on a standard speaker stand to be used as a multipurpose front of house loudspeaker.

The possibility to position the cabinet with two different angles to the floor (45° and 55°) enables it to be placed at differing distances from the musicians according to the size of the stage and to the kind of monitoring needed.

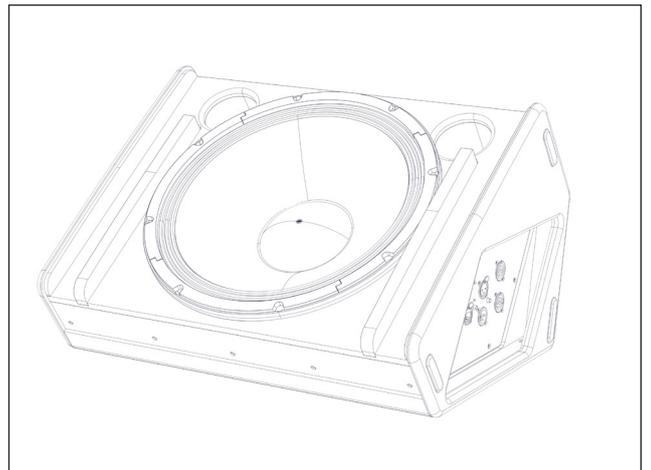

## SYSTEM PROCESSING

The system processing is based on the CORE DSP platform designed by the PROEL R&D Laboratories using one of the most advanced SHARC DSP for audio applications. It features 40bit, 96kHz floating point resolution and top quality 24bit AD/DA converters for perfect signal integrity, dynamic range in excess of 110dB, and superior sonic performance. Thanks to its massive processing power, the CORE platform is capable of providing the most sophisticated algorithms for speaker processing, together with remote control and networking capability.

The CORE DSP makes it possible to set an optimal time alignment for the crossover filter resulting in a linear phase response. The correct acoustic filtering has been achieved using the Constant Power Crossover technique that, thanks to a particular phase relation, results in a very smooth transition between LF and HF and an even dispersion in the crossover region.

The PRONET AX control software, working on a solid and reliable CANBUS based network protocol, provides an intuitive interface for the remote control of the whole system, with the possibility of EQing, delaying, managing the protection functions, and monitoring the status of the amplifier.

## CX14A frequency response

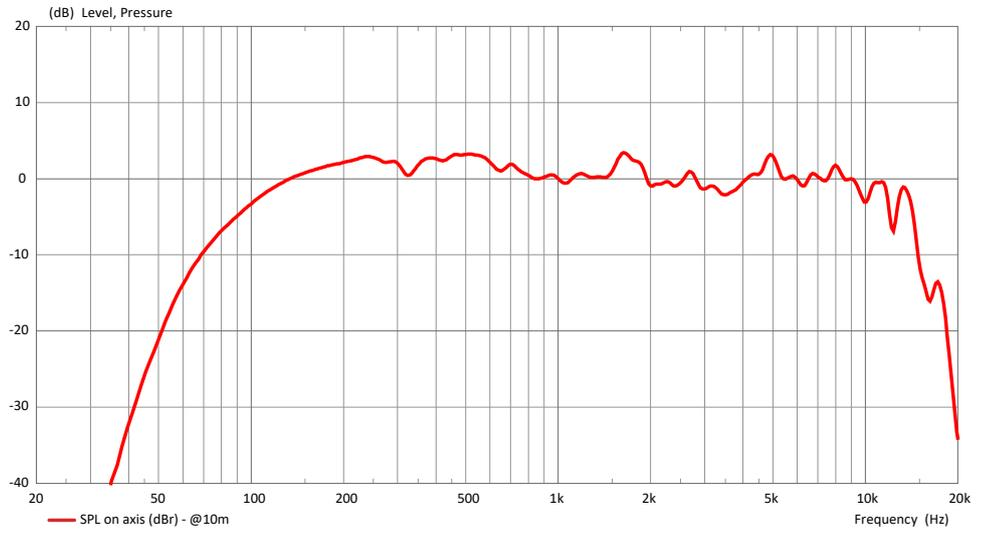

## CX14A HORIZONTAL directivity map

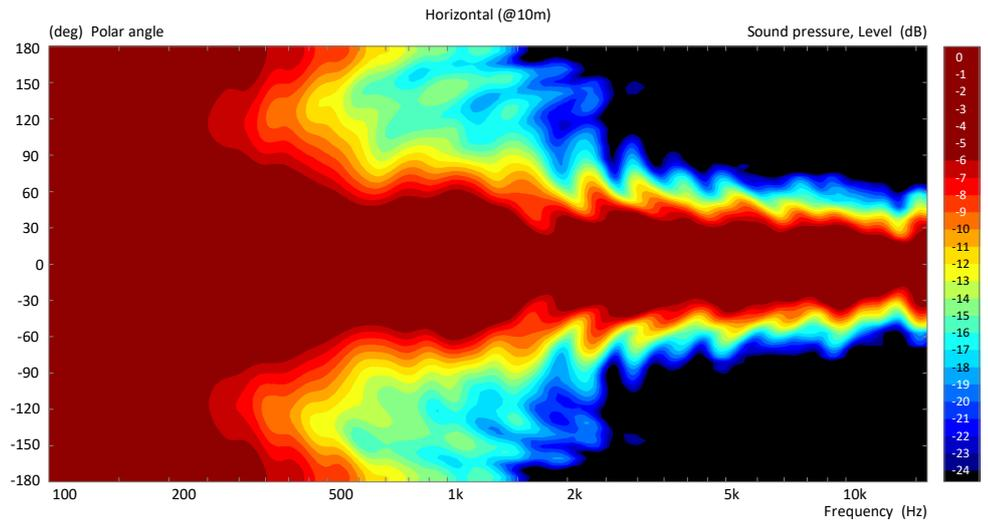

## CX14A VERTICAL directivity map

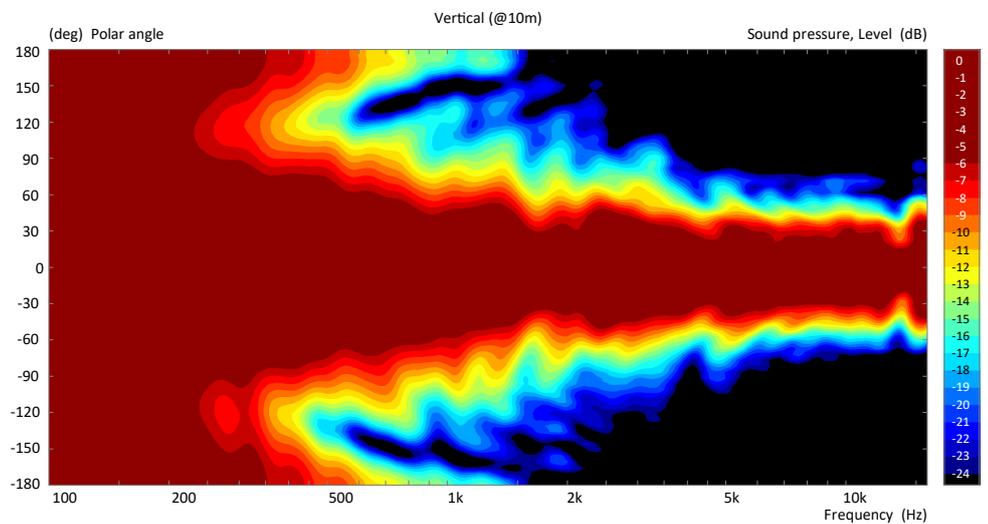

## CX14A HF HORIZONTAL polar diagram

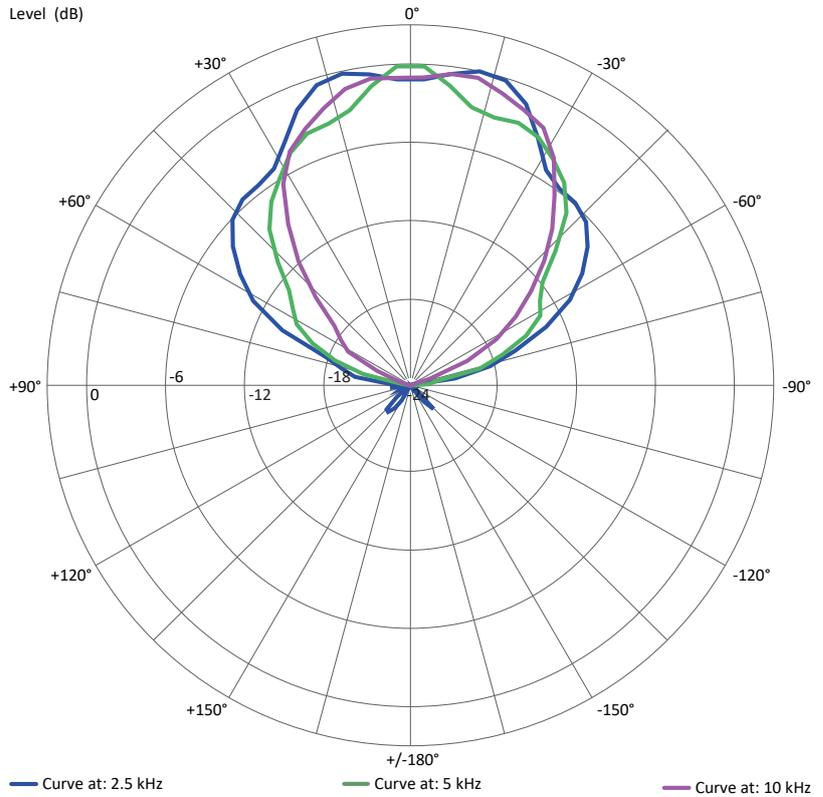

## CX14A HF VERTICAL polar diagram

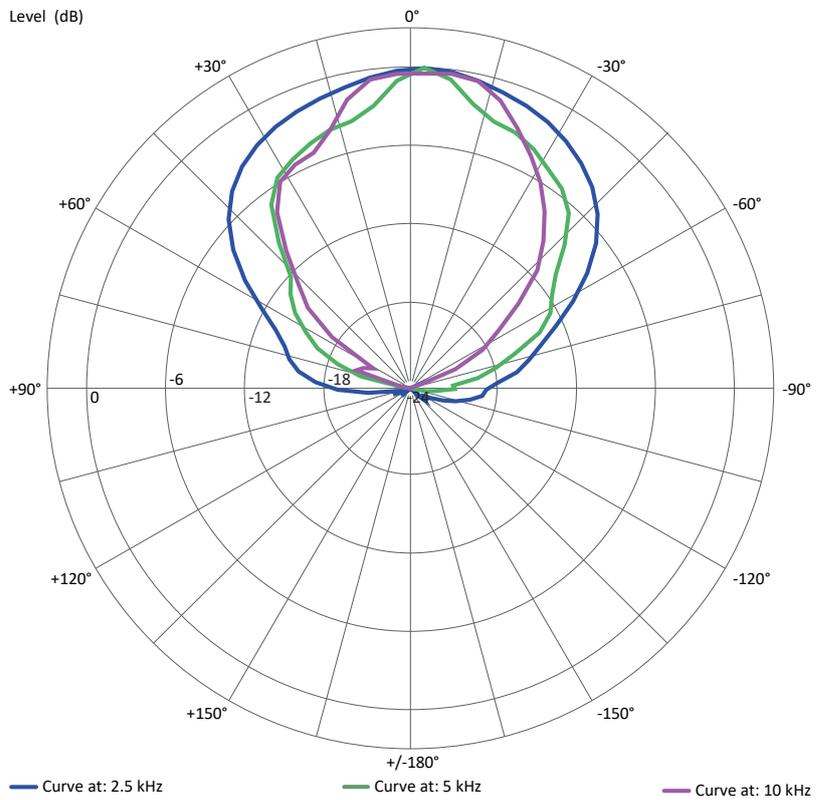

## CX14A LF HORIZONTAL polar diagram

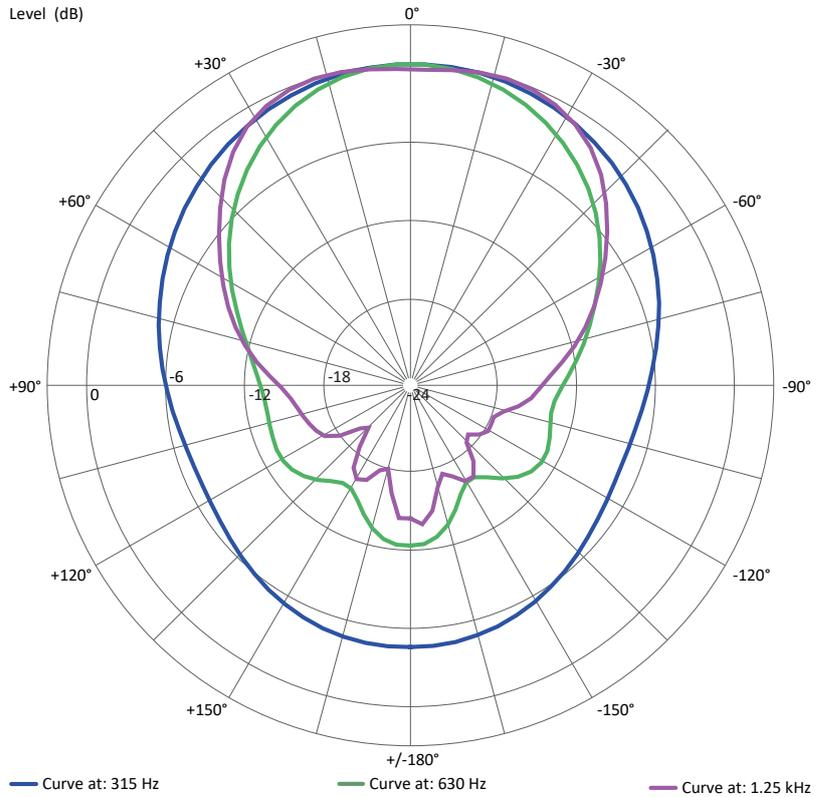

## CX14A LF VERTICAL polar diagram

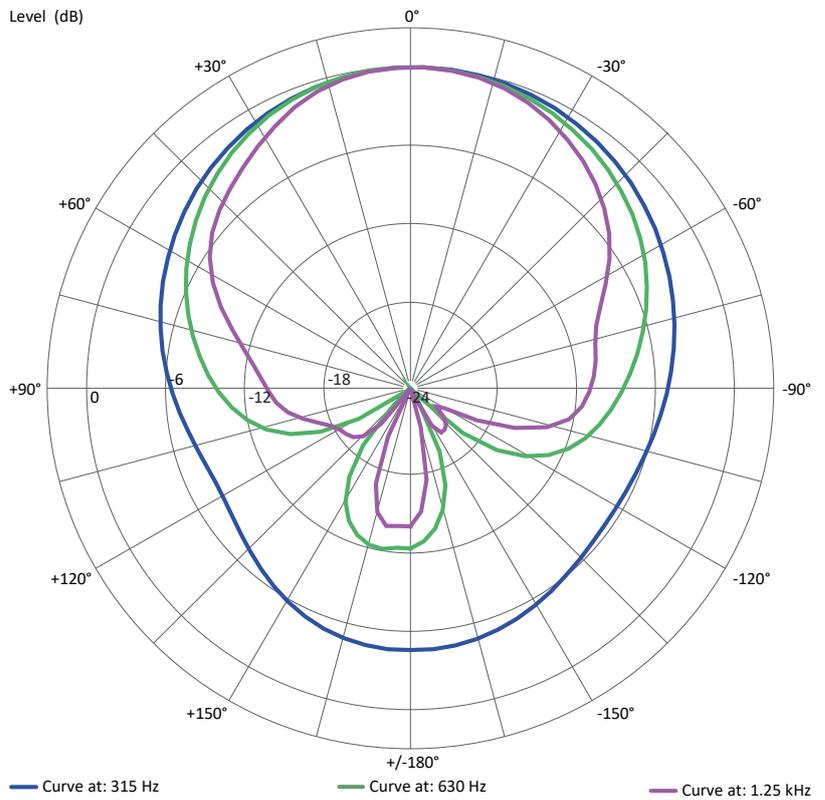

## POWER AMPLIFIER

The CX14A is powered by a DA Series Class D power amplifier with SMPS. The innovative technology used for these amplifiers offers top-of-the-range performance, such as superior sound definition at any audio frequency, very high dynamics even for low level signals, and very low distortion even at maximum power.

The superior sound quality can be compared with top-of-the-range AB-class analogue systems, while the DA module features higher dynamic range, very compact size, light weight, and efficiency better than 90%. Output power is optimised specifically to the drive units for efficient power transfer, with the low frequency section producing 900 watts and 300 watts being available for the high frequency compression driver. Input and link connections are via balanced 3-pin XLR connectors, and a ground lift switch is provided for hum-free operation. Mains power is connected through a locking Neutrik® powerCON™, and a power out connector allows mains power to be linked to additional CX14A cabinets.

## ENGINEERING DRAWING

